



KATALOG WYROBÓW









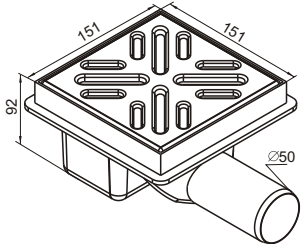

SYFONY, SPŁUCZKI, SEDESY, RURY KOMBINOWANE, WPUSTY I KRATKI ŚCIEKOWE

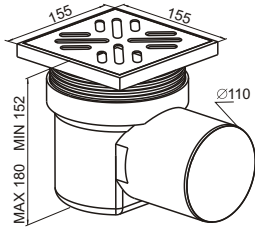

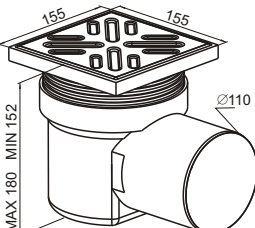
www.rawiplast.pl

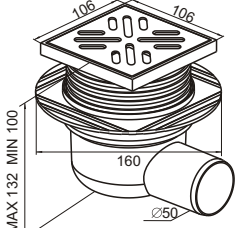

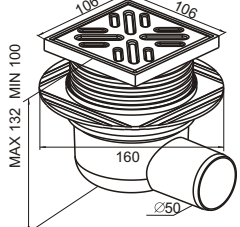

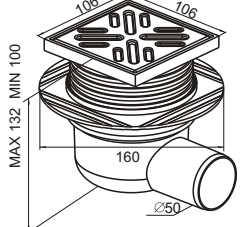

GRUPA I: WPUSTY, KRATKI ŚCIEKOWE



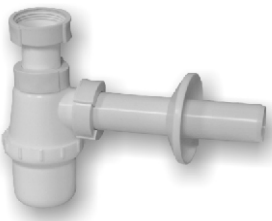
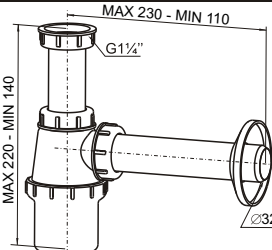
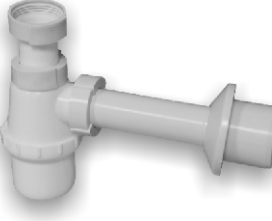
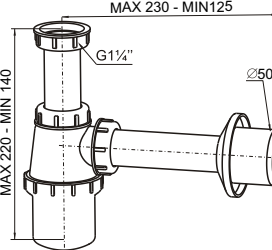

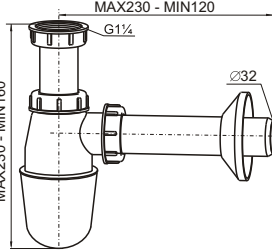
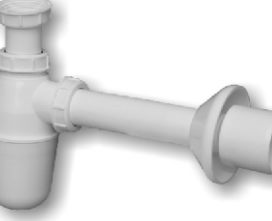
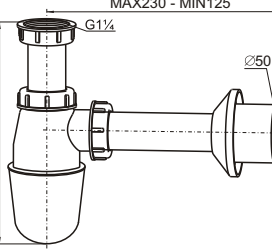
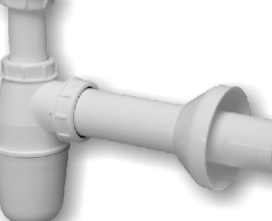
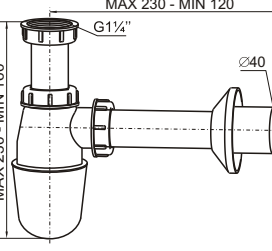

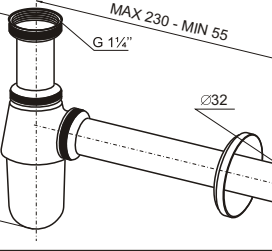

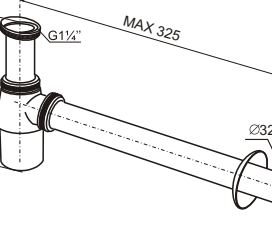
| PRODUKT | | | INDEX | OPK |
|---|---|--|-------|-----|
|  |  | Kratka ściekowa pionowa Ø50 biała | C101B | 35 |
| | | Kratka ściekowa pionowa Ø50 czarna | C102C | 35 |
|  |  | Kratka ściekowa pionowa Ø110 biała | C103B | 10 |
| | | Kratka ściekowa pionowa Ø110 czarna | C104C | 10 |
|  |  | Kratka ściekowa pionowa Ø50 z regul. poziomem biała | C105B | 10 |
| | | Kratka ściekowa pionowa Ø50 z regul. poziomem popielata | C106P | 10 |
|  |  | Kratka ściekowa pionowa Ø50 z regul. poziomem, ruszt nierdzewny | C107N | 10 |
| | | Kratka ściekowa pionowa Ø50 z regul. poziomem, ruszt nierdzewny, przykręcany | C108N | 10 |
|  |  | Wpust ściekowy poziomy Ø50 ruszt biały* | C201B | 40 |
| | | Wpust ściekowy poziomy Ø50 ruszt czarny* | C202C | 40 |
|  |  | Wpust ściekowy poziomy Ø50 biał | C203B | 50 |
| | | Wpust ściekowy poziomy Ø50 czarny | C204C | 50 |
|  |  | Wpust ściekowy poziomy z korkiem do czyszczenia Ø50 ruszt biały* | C207B | 40 |
| | | Wpust ściekowy poziomy z korkiem do czyszczenia Ø50 ruszt czarny* | C208C | 40 |

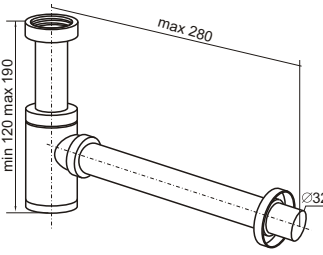

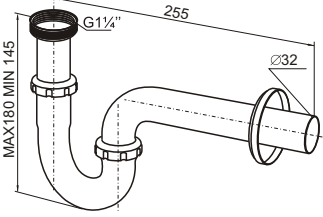
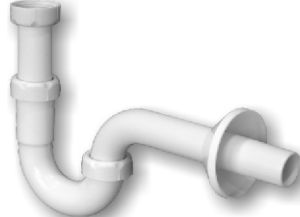
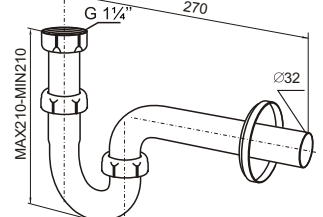
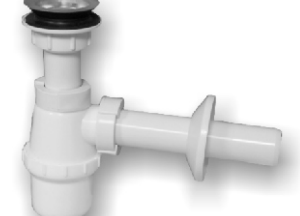
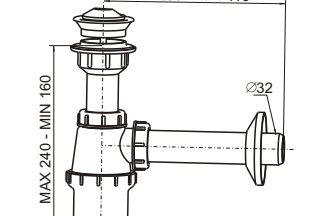
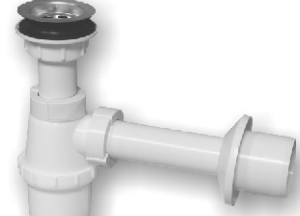
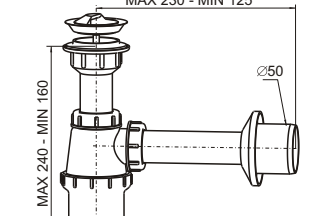

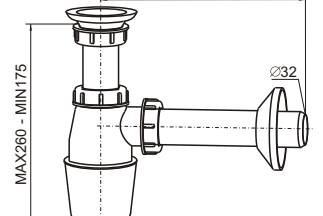

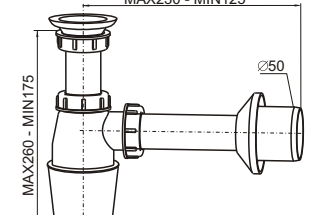

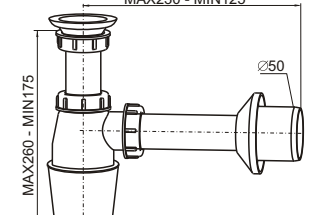

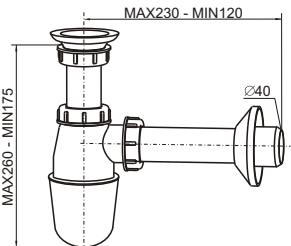

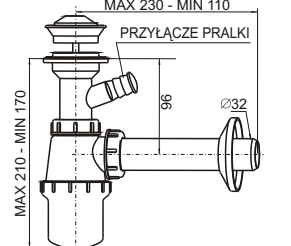

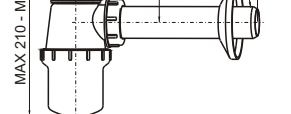
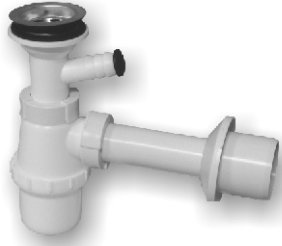
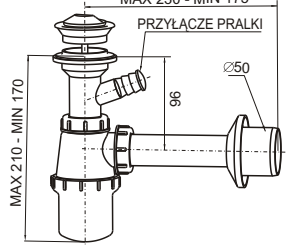
| PRODUKT | | | INDEX | OPK |
|---|---|--|-------|-----|
|  |  | <p>Wpust ściekowy poziomy z korkiem do czyszczenia Ø50 ruszt nierdzewny</p> | C209N | 20 |
|  |  | <p>Wpust ściekowy poziomy Ø110 z regulowanym poziomem, biały*</p> | C205B | 10 |
|  |  | <p>Wpust ściekowy poziomy Ø110 z regulowanym poziomem ruszt nierdzewny</p> | C206C | 10 |
|  |  | <p>Wpust ściekowy poziomy Ø50 z regulowanym poziomem, biały</p> | C210N | 10 |
|  |  | <p>Wpust ściekowy poziomy Ø50 z regulowanym poziomem, popielaty</p> | C211B | 10 |
|  |  | <p>Wpust ściekowy poziomy Ø50 z regulowanym poziomem, ruszt nierdzewny</p> | C212P | 10 |
| | | <p>Wpust ściekowy poziomy Ø50 z regulowanym poziomem, ruszt nierdzewny przykręcany</p> | C213N | 10 |
| | | | C214N | 10 |

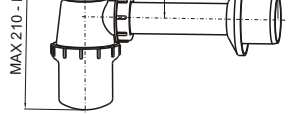

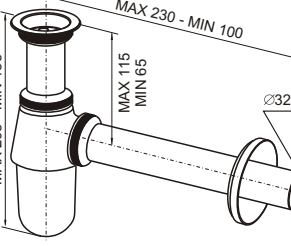

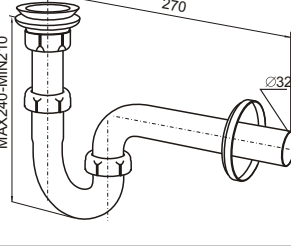

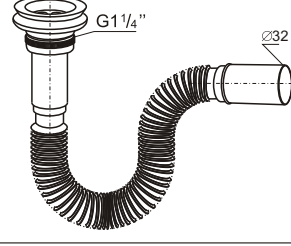

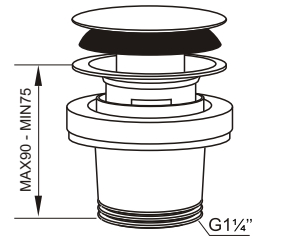

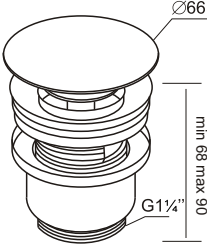

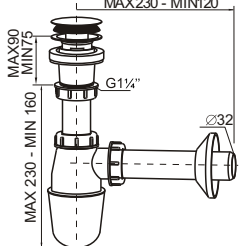
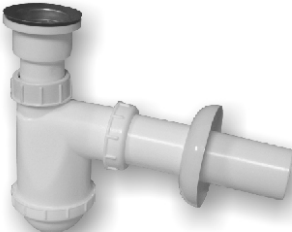
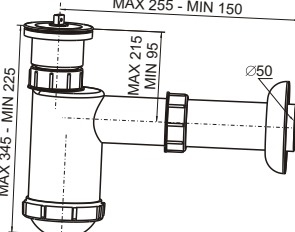

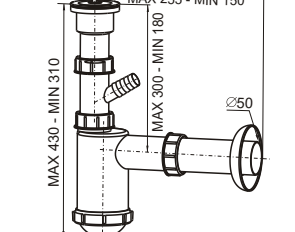
*Ruszt w kolorze białym, czarnym.

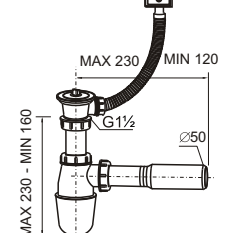

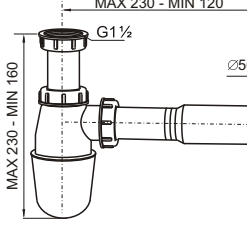
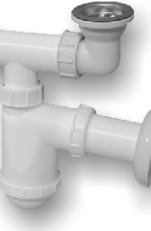
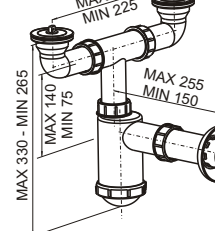

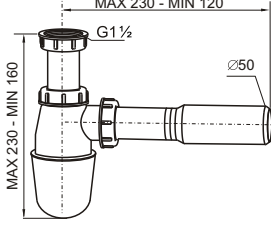

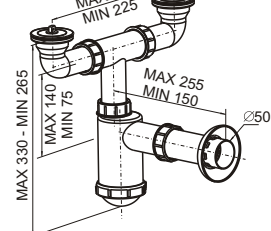

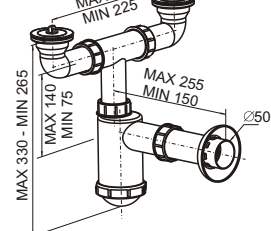
GRUPA II: SYFONY, PÓLSYFONY

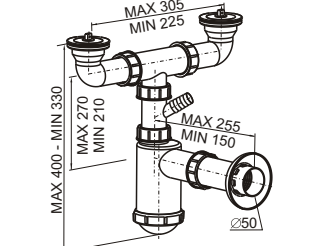

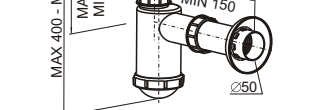

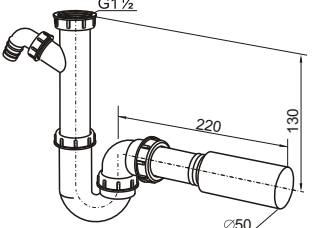

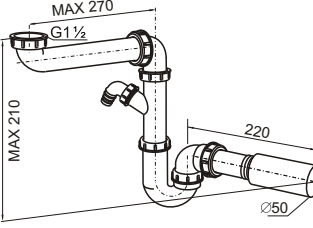
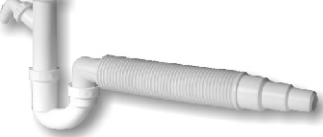
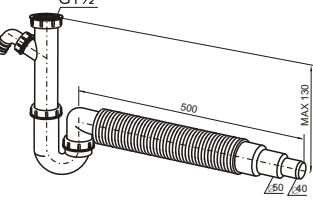
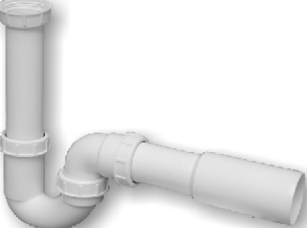
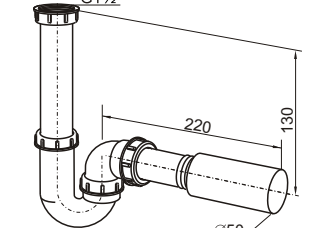
| PRODUKT | | | INDEX | OPK |
|---|---|---|---------|-----|
|  |  | <p>Półsyfon butelkowy Ø32 umywalka bidet</p> | A10032 | 60 |
|  |  | <p>Półsyfon butelkowy Ø50 umywalka bidet</p> | A10150 | 60 |
|  |  | <p>Półsyfon butelkowy Ø32 umywalka bidet</p> | A11232 | 60 |
|  |  | <p>Półsyfon butelkowy Ø50 umywalka bidet</p> | A11350 | 60 |
|  |  | <p>Półsyfon butelkowy Ø40 umywalka bidet</p> | A11440 | 60 |
|  |  | <p>Półsyfon butelkowy Ø32 umywalka bidet metalowy chromowany</p> | A12032M | 10 |
|  |  | <p>Półsyfon butelkowy Ø32 umywalka bidet metalowy mosiężny chromowany</p> | A12632M | 10 |

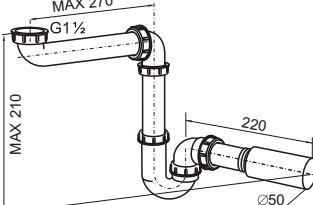
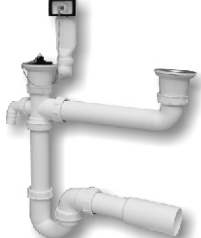
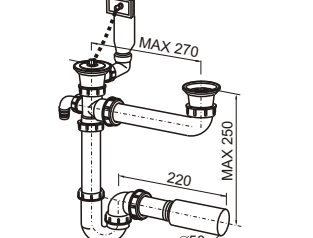

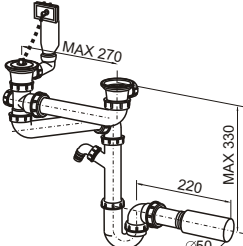

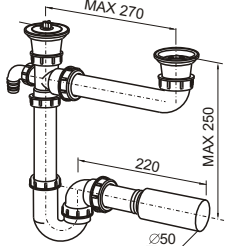
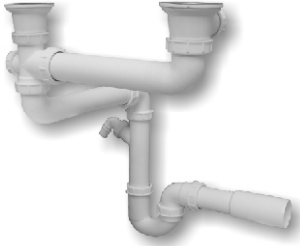
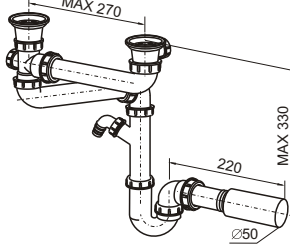
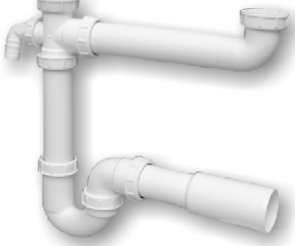
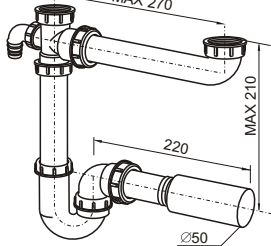

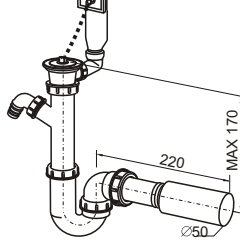

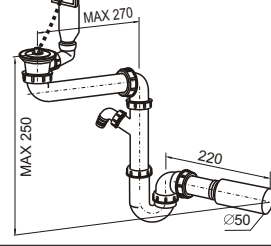
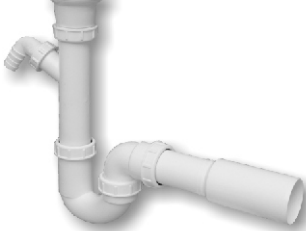
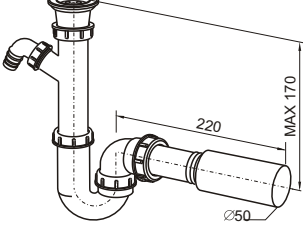

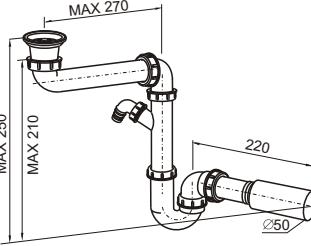

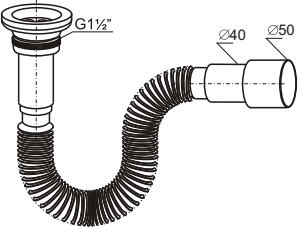
| PRODUKT | | | INDEX | OPK |
|---|---|--|---------|-----|
|  |  | <p>Półsyfon butelkowy Ø32 umywalka bidet metalowy chromowany</p> | A12332M | 1 |
|  |  | <p>Półsyfon rurowy Ø32 umywalka bidet metalowy chromowany</p> | A12132M | 10 |
|  |  | <p>Półsyfon rurowy Ø32 umywalka bidet</p> | A11632 | 30 |
|  |  | <p>Syfon butelkowy Ø32 umywalka bidet sitko tworzywo</p> | A102T32 | 70 |
|  |  | <p>Syfon butelkowy Ø32 umywalka bidet sitko metalowe</p> | A103M32 | 70 |
|  |  | <p>Syfon butelkowy Ø50 umywalka bidet sitko tworzywo</p> | A104T50 | 70 |
|  |  | <p>Syfon butelkowy Ø50 umywalka bidet sitko metalowe</p> | A105M50 | 70 |
|  |  | <p>Syfon butelkowy Ø32 umywalka bidet sitko metalowe</p> | A110M32 | 50 |
| | | <p>Syfon butelkowy Ø50 umywalka bidet sitko metalowe</p> | A111M50 | 50 |

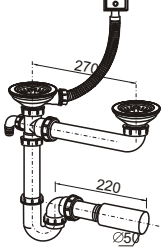

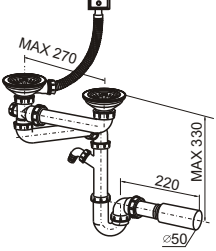

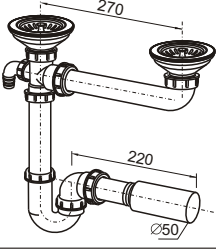

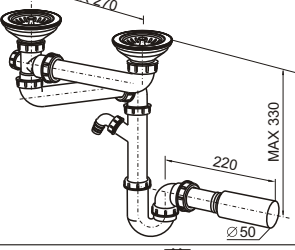

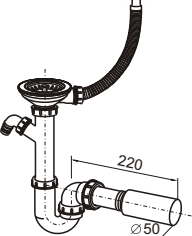

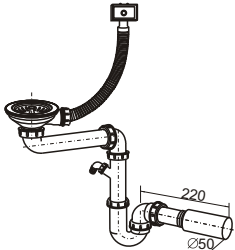

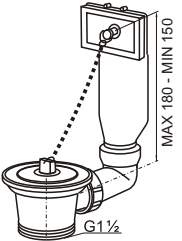
| PRODUKT | | | INDEX | OPK |
|---|---|--|----------|-----|
|  |  | <p>Syfon butelkowy Ø40 umywalka bidet sitko metalowe</p> | A115M40 | 50 |
|  |  | <p>Syfon butelkowy Ø32 umywalka bidet, sitko tworzywo z przył.do pralki</p> | A106T32 | 50 |
|  |  | <p>Syfon butelkowy Ø32 umywalka bidet, sitko metalowe z przył.do pralki</p> | A107M32 | 50 |
|  |  | <p>Syfon butelkowy Ø50 umywalka bidet, sitko tworzywo z przył.do pralki</p> | A108T50 | 50 |
|  |  | <p>Syfon butelkowy Ø50 umywalka bidet, sitko metalowe z przył.do pralki</p> | A109M50 | 50 |
|  |  | <p>Syfon butelkowy Ø32 umywalka bidet metalowy chromowany sitko metalowe</p> | A122M32M | 10 |
|  |  | <p>Syfon rurowy Ø32 umywalka bidet sitko metalowe</p> | A117M32 | 30 |
|  |  | <p>Syfon uniwersalny Ø32 umywalka bidet sitko metalowe</p> | A118M32 | 25 |
|  |  | <p>Spust umywalka bidet Klik Klak Korek metalowy spust z tworzywa</p> | A119 | 25 |

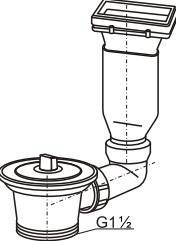

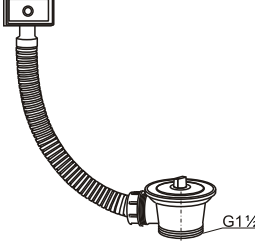

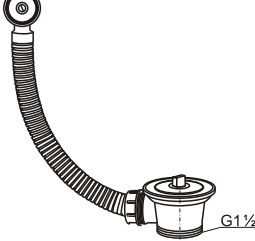

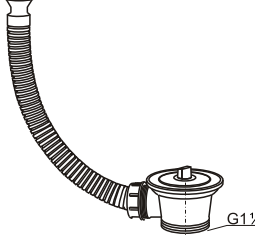

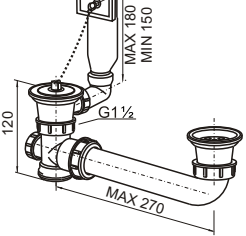
| PRODUKT | | | INDEX | OPK |
|---|---|--|---------|-----|
|  |  | <p>Spust umywalka bidet Klik Klak Korek metalowy spust metalowy</p> | A125 | 1 |
|  |  | <p>Syfon butelkowy Ø32 umywalka bidet ze spustem Klik Klak Korek metalowy spust z tworzywa</p> | A124M32 | 10 |
|  |  | <p>Syfon butelkowy zlew pojedynczy sitko tworzywo</p> | A201T50 | 40 |
|  |  | <p>Syfon butelkowy zlew pojedynczy sitko metalowe</p> | A202M50 | 40 |
|  |  | <p>Syfon butelkowy zlew pojedynczy sitko tworzywo z przył. do pralki, zmywarki</p> | A207T50 | 40 |
|  |  | <p>Syfon butelkowy zlew pojedynczy sitko metalowe z przył. do pralki, zmywarki</p> | A208M50 | 40 |
|  |  | <p>Syfon butelkowy zlew pojedynczy z zestawem odpływowo przelewowym sitko metalowe</p> | A262M50 | 10 |
|  |  | <p>Syfon butelkowy zlew bez zestawu odpływowego</p> | A26350 | 10 |
|  |  | <p>Syfon butelkowy zlew podwójny sitko tworzywo</p> | A203T50 | 25 |
|  |  | <p>Syfon butelkowy zlew podwójny sitko metalowe</p> | A204M50 | 25 |

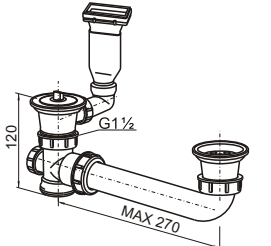

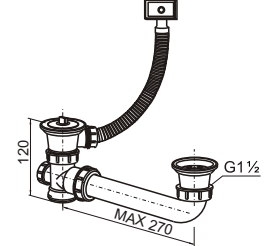

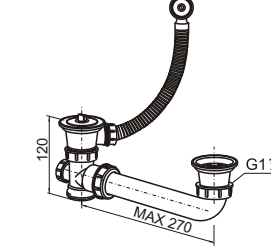

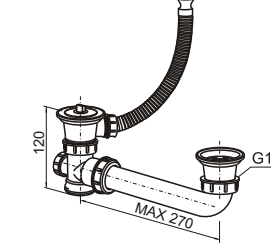

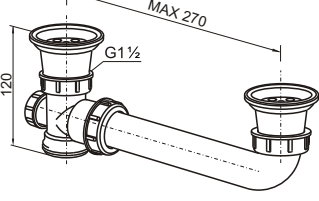
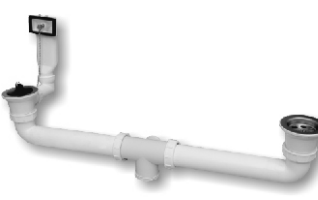
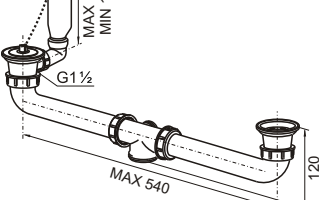
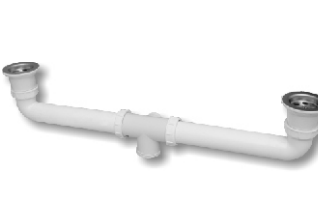
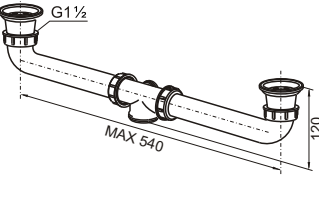

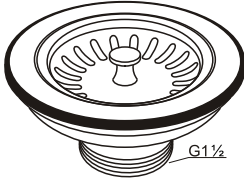

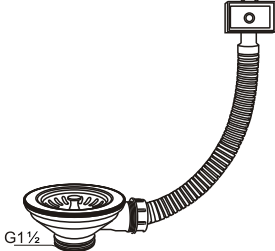
| PRODUKT | | | INDEX | OPK |
|---|---|---|---------|-----|
|  |  | <p>Syfon butelkowy zlew podwójny, sitko tworzywo z przył. pralki, zmywarki</p> | A205T50 | 25 |
|  |  | <p>Syfon butelkowy zlew podwójny, sitko metalowe z przył. do pralki, zmywarki</p> | A206M50 | 25 |
|  |  | <p>Syfon rurowy zlew z przył. do pralki, zmywarki</p> | A20950 | 10 |
|  |  | <p>Syfon rurowy zlew z możliwością montażu przy ścianie z przył. do pralki, zmywarki</p> | A21050 | 10 |
|  |  | <p>Syfon rurowy zlew z przyłączem do pralki, zmywarki, rura odpływowa elastyczna</p> | A22650 | 10 |
|  |  | <p>Syfon rurowy zlew</p> | A21150 | 10 |
|  |  | <p>Syfon rurowy zlew z możliwością montażu przy ścianie</p> | A21250 | 10 |
|  |  | <p>Syfon rurowy zlew podwójny z zestawem odpływowo przelewowym z przył. pralki, zmywarki, sitka metalowe z łańcuszkiem do korka</p> | A213M50 | 10 |

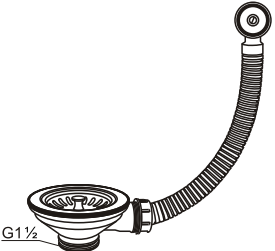

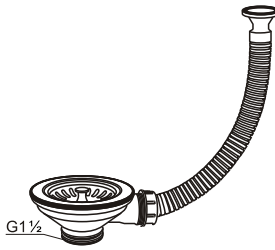

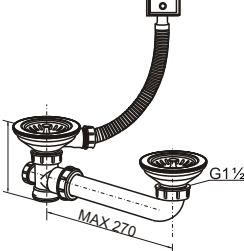

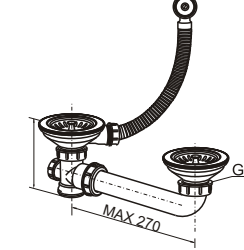

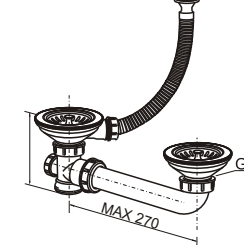

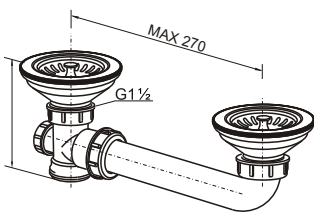

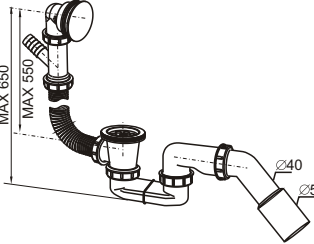
| PRODUKT | | INDEX | OPK |
|---|---|---|-----------------------|
|  |  | <p>Syfon rurowy zlew podwójny z zestawem odpływowo przelewowym z przył. pralki, zmywarki sitka metal. z łańcuszkiem do korka z możliwością montażu przy ścianie</p> | <p>A214M50 10</p> |
|  |  | <p>Syfon rurowy zlew podwójny z zestawem odpływowym z przył. pralki, zmywarki sitka metalowe</p> | <p>A215M50 10</p> |
|  |  | <p>Syfon rurowy zlew podwójny z zestawem odpływowym z przył. pralki, zmywarki sitka metalowe z możliwością montażu przy ścianie</p> | <p>A216M50 10</p> |
|  |  | <p>Syfon rurowy zlew podwójny z przył. pralki, zmywarki</p> | <p>A22750 10</p> |
|  |  | <p>Syfon rurowy zlew pojedynczy z zestawem odpływowo przelewowym z przył. pralki, zmywarki sitka metalowe z łańcuszkiem do korka</p> | <p>A217M50 10</p> |
|  |  | <p>Syfon rurowy zlew pojedynczy z zestawem odpływowo przelewowym z przył. pralki, zmywarki sitka metal. z łańcuszkiem do korka z możliwością montażu przy ścianie</p> | <p>A218M50 10</p> |
|  |  | <p>Syfon rurowy zlew pojedynczy z zestawem odpływowym z przył. pralki, zmywarki sitka metalowe z łańcuszkiem do korka</p> | <p>A219M50 10</p> |

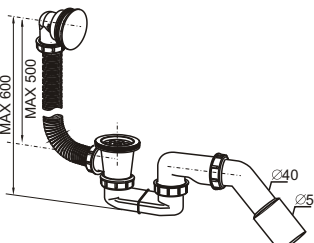

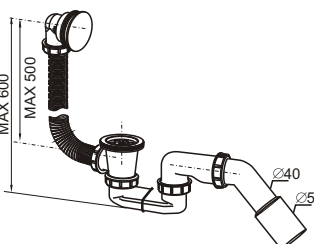

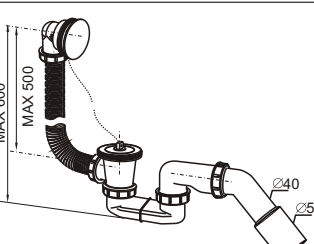

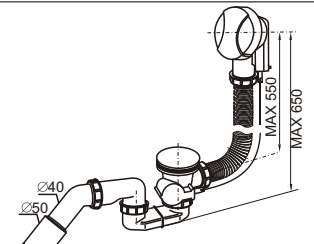

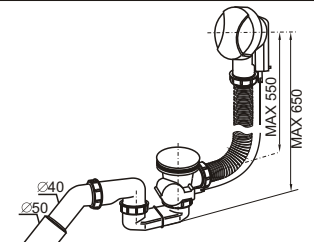

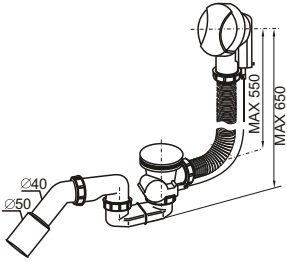

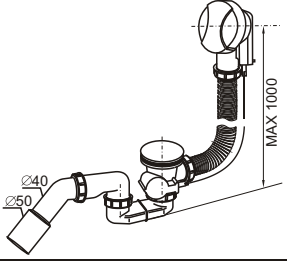

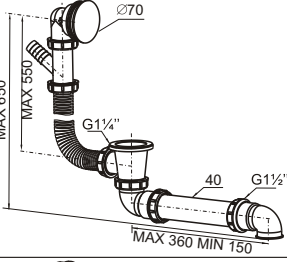

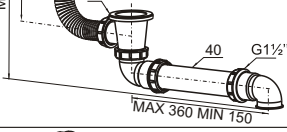

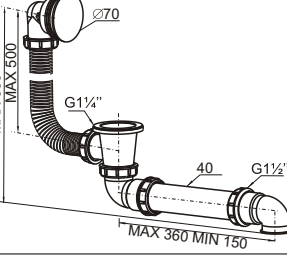

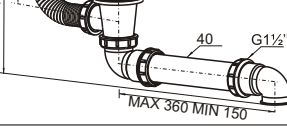
| PRODUKT | | | INDEX | OPK |
|---|---|--|---------|-----|
|  |  | <p>Syfon rurowy zlew pojedynczy z zestawem odpływowym z przył. pralki, zmywarki sitka metal. z łańcuszkiem do korka z możliwością montażu przy ścianie</p> | A220M50 | 10 |
|  |  | <p>Syfon uniwersalny zlew pojedynczy z zestawem odpływowym sitko metalowe</p> | A230M50 | 25 |
|  |  | <p>Syfon rurowy zlew podwójny z zestawem odpływowo przelewowym z przył. pralki, zmywarki do zlewozmywaków z otworami odpływowymi 3,5"</p> | A244M50 | 1 |
|  |  | <p>Syfon rurowy zlew podwójny z zestawem odpływowo przelewowym z przył. pralki, zmywarki z możliwością montażu przy ścianie do zlewozmywaków z otworami odpływowymi 3,5"</p> | A245M50 | 1 |
|  |  | <p>Syfon rurowy zlew podwójny z zestawem odpływowym z przył. pralki, zmywarki do zlewozmywaków z otworami odpływowymi 3,5"</p> | A246M50 | 1 |
|  |  | <p>Syfon rurowy zlew podwójny z zestawem odpływowym z przył. pralki, zmywarki z możliwością montażu przy ścianie do zlewozmywaków z otworami odpływowymi 3,5"</p> | A247M50 | 1 |
|  |  | <p>Syfon rurowy zlew pojedynczy z zestawem odpływowo przelewowym z przył. pralki, zmywarkido zlewozmywaków z otworami odpływowymi 3,5"</p> | A248M50 | 1 |

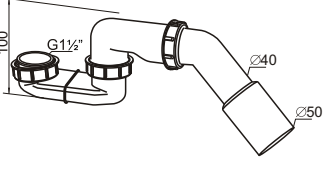

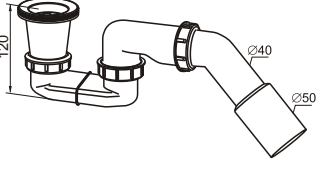

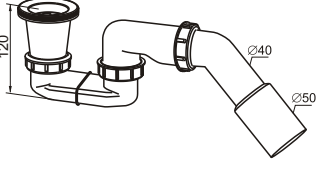

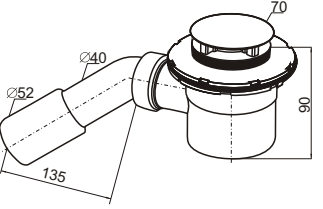

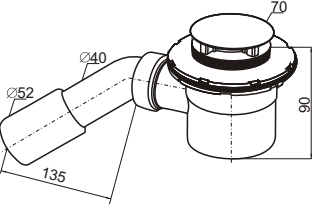

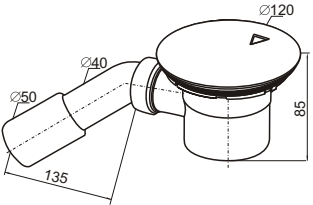
| PRODUKT | | | INDEX | OPK |
|---|---|--|---------|-----|
|  |  | <p>Syfon rurowy zlew pojedynczy z zestawem odpływowo przelewowym z przył. pralki, zmywarki z możliwością montażu przy ścianie do zlewozmywaków z otworami odpływowymi 3,5"</p> | A249M50 | 1 |
|  |  | <p>Zestaw odpływowo przelewowy zlew z łańcuszkiem do korka</p> | A221 | 10 |
|  |  | <p>Zestaw odpływowo przelewowy zlew przelew prostokątny pionowy</p> | A254 | 10 |
|  |  | <p>Zestaw odpływowo przelewowy zlew z łańcuszkiem do korka przelew prostokątny poziomy</p> | A255 | 10 |
|  |  | <p>Zestaw odpływowo przelewowy zlew przelew okrągły poziomy</p> | A256 | 10 |
|  |  | <p>Zestaw odpływowo przelewowy zlew przelew okrągły pionowy</p> | A257 | 10 |
|  |  | <p>Zestaw odpływowo przelewowy zlew podwójny z łańcuszkiem do korka</p> | A222 | 10 |

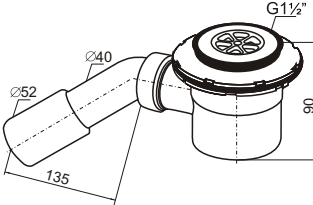
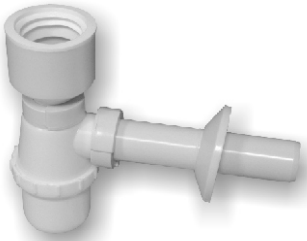
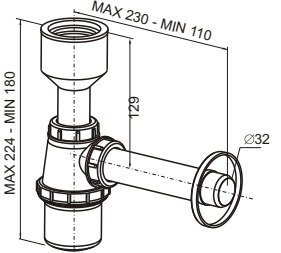
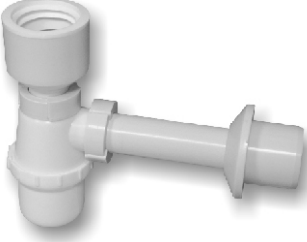
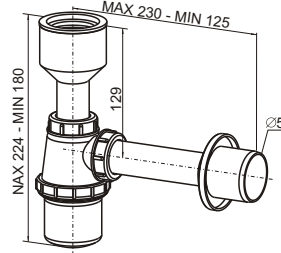

| PRODUKT | | | INDEX | OPK |
|---|---|---|-------|-----|
|  |  | <p>Zestaw odpływowo przelewowy zlew podwójny przelew prostokątny pionowy</p> | A258 | 10 |
|  |  | <p>Zestaw odpływowo przelewowy zlew podwójny z łańcuszkiem do korka przelew prostokątny poziomy</p> | A259 | 10 |
|  |  | <p>Zestaw odpływowo przelewowy zlew podwójny przelew okrągły poziomy</p> | A260 | 1 |
|  |  | <p>Zestaw odpływowo przelewowy zlew podwójny przelew okrągły pionowy</p> | A261 | 1 |
|  |  | <p>Zestaw odpływowy zlew podwójny</p> | A223 | 10 |
|  |  | <p>Zestaw odpływowo przelewowy zlew podwójny z łańcuszkiem do korka</p> | A224 | 10 |
|  |  | <p>Zestaw odpływowy zlew podwójny</p> | A225 | 10 |

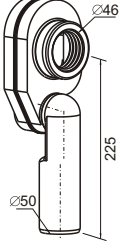
| PRODUKT | | INDEX | OPK |
|---|---|--|-----------|
|  |  | Zestaw odpływowy zlew do zlewozmywaków z otworami odpływowymi 3,5" | A240 1 |
|  |  | Zestaw odpływowo przelewowy zlew przelew prostokątny poziomy do zlewozmywaków z otworami odpływowymi 3,5" | A241 1 |
|  |  | Zestaw odpływowo przelewowy zlew przelew okrągły poziomy do zlewozmywaków z otworami odpływowymi 3,5" | A250 1 |
|  |  | Zestaw odpływowo przelewowy zlew przelew okrągły pionowy do zlewozmywaków z otworami odpływowymi 3,5" | A251 1 |
|  |  | Zestaw odpływowo przelewowy zlew podwójny przelew prostokątny poziomy do zlewozmywaków z otworami odpływowymi 3,5" | A242 1 |
|  |  | Zestaw odpływowo przelewowy zlew podwójny przelew okrągły poziomy do zlewozmywaków z otworami odpływowymi 3,5" | A252 1 |
|  |  | Zestaw odpływowo przelewowy zlew podwójny przelew okrągły pionowy do zlewozmywaków z otworami odpływowymi 3,5" | A253 1 |

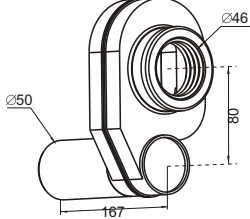

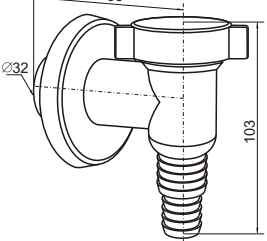

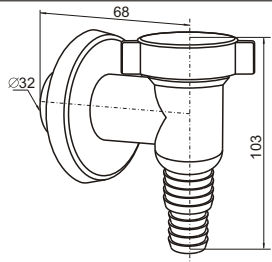

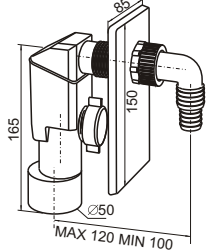
| PRODUKT | | | INDEX | OPK |
|---|---|---|----------|-----|
|  |  | <p>Zestaw odpływowy zlew podwójny do zlewozmywaków z otworami odpływowymi 3,5"</p> | A243 | 1 |
|  |  | <p>Syfon wannowy nadstropowy sitko tworzywo przył. pralki</p> | A301T50 | 30 |
|  |  | <p>Syfon wannowy nadstropowy sitko tworzywo</p> | A308T50 | 30 |
|  |  | <p>Syfon wannowy nadstropowy sitko metalowe przelew metalowy</p> | A309M50 | 30 |
|  |  | <p>Syfon wannowy nadstropowy sitko metalowe przelew metalowy z łańcuszkiem do korka</p> | A312M50 | 30 |
|  |  | <p>Syfon wannowy nadstropowy automat chrom</p> | A305M50 | 20 |
|  |  | <p>Syfon wannowy nadstropowy automat srebrny matowy</p> | A315TM50 | 10 |



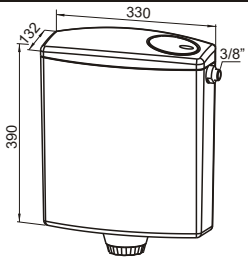

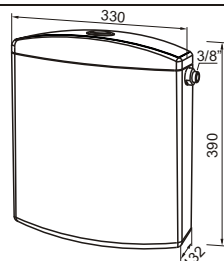

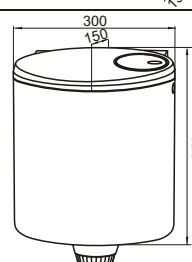

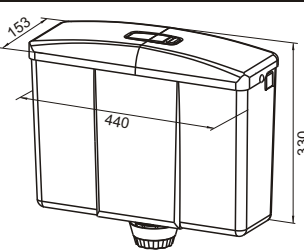
| PRODUKT | | | INDEX | OPK |
|---|---|---|---------|-----|
|  |  | Syfon wannowy nadstropowy automat biały | A314T50 | 10 |
|  |  | Syfon wannowy nadstropowy automat chrom do dużych wanien rura przelewu 100cm | A316M50 | 1 |
|  |  | Urządzenie przelew. spustowe do wanny sitko tworzywo z przył. do pralki | A303T50 | 20 |
|  |  | Urządzenie przelew. spustowe do wanny sitko metalowe z przył. do pralki | A304M50 | 20 |
|  |  | Urządzenie przelew. spustowe do wanny sitko tworzywo | A310T50 | 20 |
|  |  | Urządzenie przelew. spustowe do wanny sitko metalowe | A311M50 | 20 |
|  |  | Syfon wanna brodzik nadstropowy | A41050 | 20 |
|  |  | Syfon brodzikowy sitko tworzywo | A401T50 | 50 |
|  |  | Syfon brodzikowy sitko metalowe | A402M50 | 50 |
|  |  | Syfon brodzikowy chromowany do brodzika z otworem odpływ. Ø52, czyszczony od góry | A405M50 | 10 |
|  |  | Syfon brodzikowy biały do brodzika z otworem odpływ. Ø52, czyszczony od góry | A406T50 | 10 |

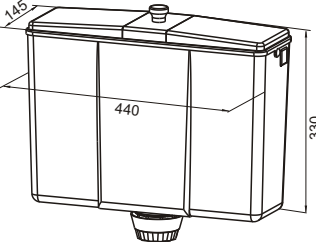
| PRODUKT | | | INDEX | OPK |
|---|---|---|----------|-----|
|  |  | <p>Syfon brodzikowy chromowany do brodzika z otworem odpływ. Ø90, czyszczony od góry</p> | A407CH50 | 10 |
|  |  | <p>Syfon brodzikowy biały do brodzika z otworem odpływ. Ø90, czyszczony od góry</p> | A408T50 | 10 |
|  |  | <p>Syfon brodzikowy sitko chromowane do brodzika z otworem odpływowym Ø52, czyszczony od góry</p> | A409CH50 | 10 |
|  |  | <p>Syfon butelkowy Ø32 pisuar</p> | A50132 | 30 |
|  |  | <p>Syfon butelkowy Ø50 pisuar</p> | A50250 | 30 |
|  |  | <p>Syfon pisuarowy pionowy</p> | A50350 | 12 |
|  |  | <p>Syfon pisuarowy poziomy</p> | A50450 | 12 |
|  |  | <p>Syfon do podłączenia pralki Ø32 natynkowy, biały</p> | A60032 | 20 |

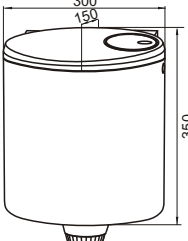

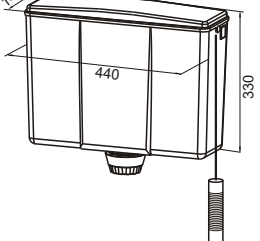

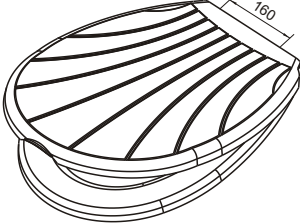

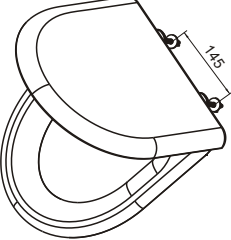



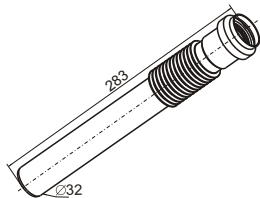

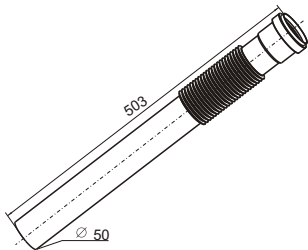
| PRODUKT | | | INDEX | OPK |
|---|---|---|---------|-----|
|  |  | Syfon do podłączenia pralki Ø32 natynkowy, chromowany | A60132 | 20 |
|  |  | Syfon do podłączenia pralki Ø50 podtynkowy chromowany | A603M50 | 20 |
| | | Syfon do podłączenia pralki Ø50 podtynkowy biały | A602T50 | 20 |

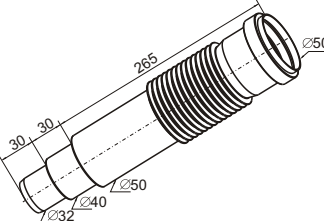

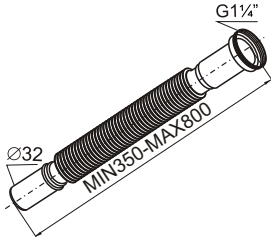

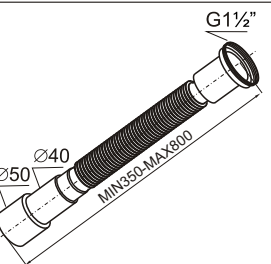

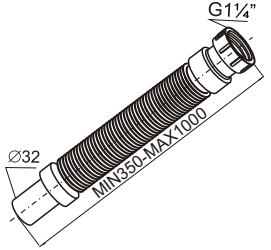

GRUPA III: SPŁUCZKI, DESKI SEDESOWE

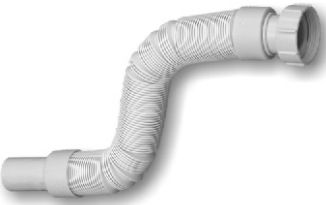
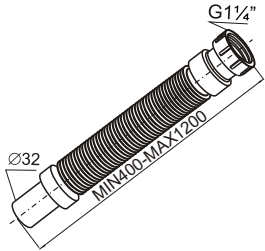
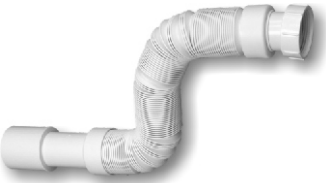
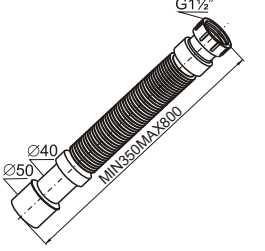
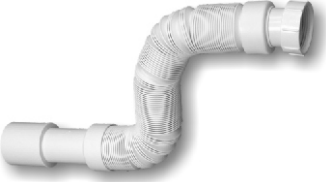
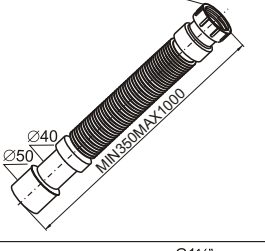

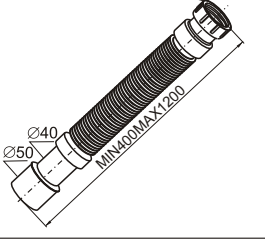

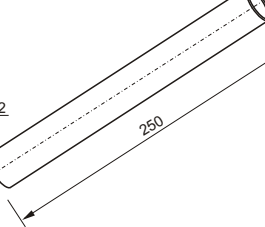

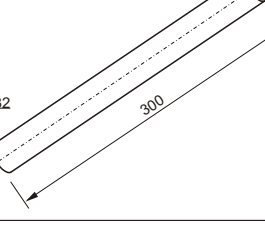
| PRODUKT | | | INDEX | OPK |
|---|---|--|-------|-----|
|  |  | Dolnośluk klawiszowy RAWKA z ABS z wkładem styropianowym, funkcja start-stop | B106K | 5 |
|  |  | Dolnośluk z ABS AURA z przyciskiem chromowanym z wkładem styropianowym, funkcja stop-start | B109P | 5 |
|  |  | Dolnośluk klawiszowy przyłącze boczne z wkładem styropianowym, funkcja stop-start | B108K | 5 |
|  |  | Dolnośluk klawiszowy przyłącze boczne, funkcja stop-start | B101K | 5 |

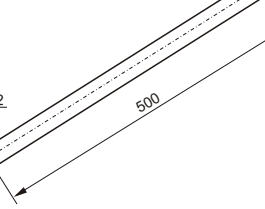

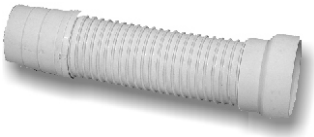
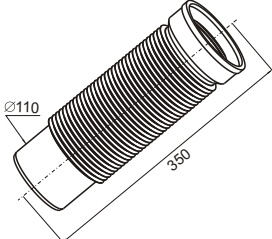
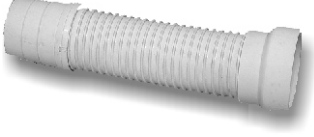
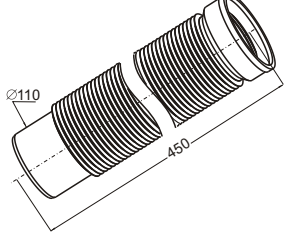
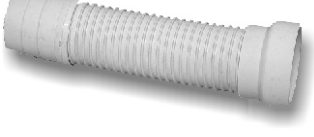
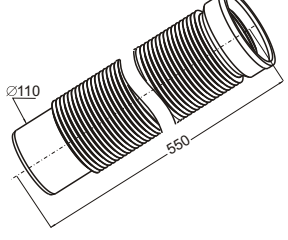
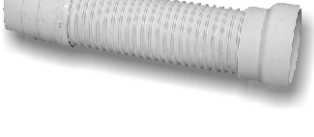
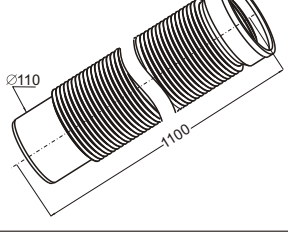

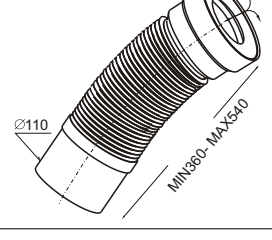

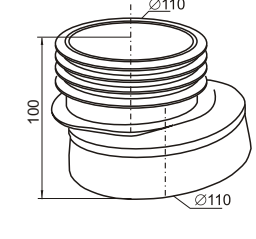

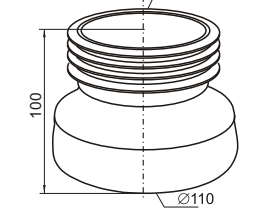

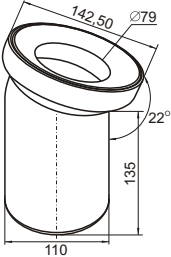

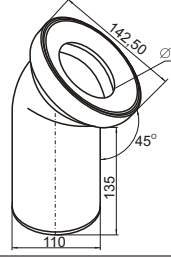
| PRODUKT | | | INDEX | OPK |
|---|---|--|-------|-----|
|  |  | <p>Dolnopluk z ciągłym przyłącze boczne</p> | B103C | 5 |
|  |  | <p>Dolnopluk klawiszowy przyłącze boczne, funkcja stop-start</p> | B107K | 5 |
|  |  | <p>Górnoopluk</p> | B104 | 5 |
|  |  | <p>Deska sedesowa</p> | B201 | 10 |
|  |  | <p>Deska sedesowa Pasuje do kompaktu Eko Cersanit, Pilch Jasienica</p> | B203 | 5 |

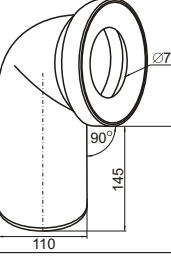

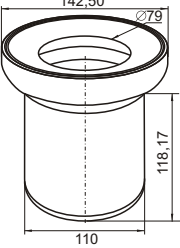

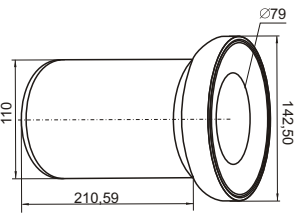
GRUPA IV: RURY PRZYŁĄCZENIOWE

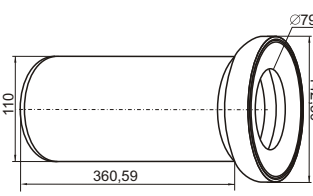

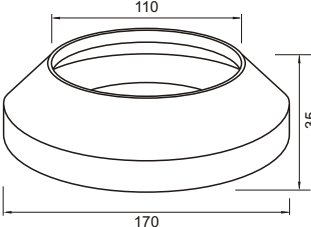

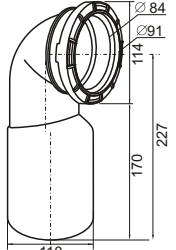
| PRODUKT | | | INDEX | OPK |
|--|---|--|-------|-----|
|  |  | Rura sanitarna kombinowana 32x300 | B301 | 50 |
|  |  | Rura sanitarna kombinowana 50x500 | B302 | 40 |
|  |  | Złącze elastyczne 50/32 wieloredukcyjne L-260 | B303 | 50 |
|  |  | Złącze uniwersalne rozciągane 5/4" 32 L-350-800 nakrętka metalowa | B310 | 30 |
|  |  | Złącze uniwersalne rozciągane 6/4" 40/50 L-350-800 nakrętka metalowa | B311 | 30 |
|  |  | Złącze uniwersalne rozciągane 5/4" 32 L-300-800 nakrętka plastikowa | B312 | 40 |
|  |  | Złącze uniwersalne rozciągane 5/4" 32 L-350-1000 nakrętka plastikowa | B313 | 30 |

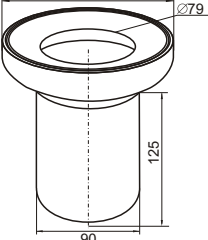
| PRODUKT | | | INDEX | OPK |
|--|---|---|-------|-----|
|  |  | <p>Złącze uniwersalne rozciągane 5/4" 32 L-400-1200 nakrętka plastikowa</p> | B314 | 30 |
|  |  | <p>Złącze uniwersalne rozciągane 6/4" 40/50, L-350-800 nakrętka plastikowa</p> | B315 | 20 |
|  |  | <p>Złącze uniwersalne rozciągane 6/4" 40/50, L-350-1000 nakrętka plastikowa</p> | B316 | 20 |
|  |  | <p>Złącze uniwersalne rozciągane 6/4" 40/50, L-400-1200 nakrętka plastikowa</p> | B317 | 20 |
|  |  | <p>Rura metalowa chrom syfonu umywalkowego 32x250</p> | B330 | 10 |
|  |  | <p>Rura metalowa chrom syfonu umywalkowego 32x300</p> | B331 | 10 |
|  |  | <p>Rura metalowa chrom syfonu umywalkowego 32x500</p> | B332 | 10 |

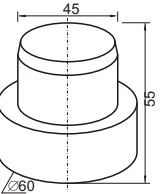
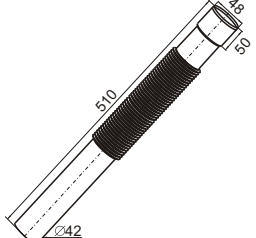

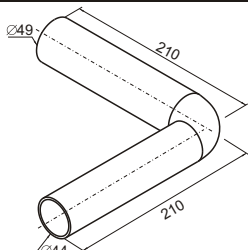

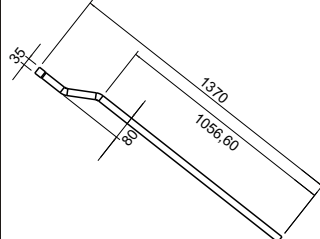
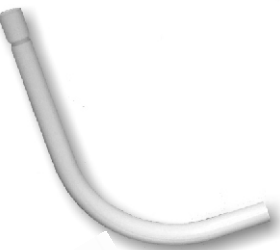
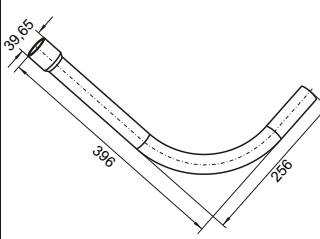

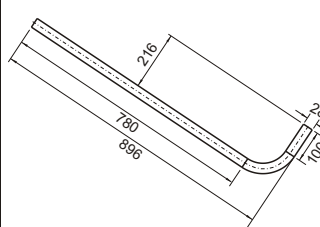



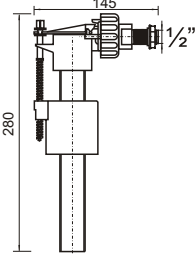

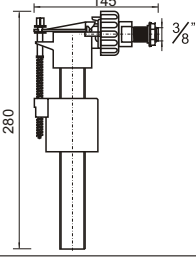
| PRODUKT | | | INDEX | OPK |
|--|---|--|-------|-----|
|  |  | Złącze uniwersalne Ø110 do WC L-350 | B401 | 15 |
|  |  | Złącze uniwersalne Ø110 do WC L-450 | B402 | 10 |
|  |  | Złącze uniwersalne Ø110 do WC L-550 | B403 | 10 |
|  |  | Złącze uniwersalne Ø110 do WC L-1100 | B404 | 1 |
|  |  | Złącze uniwersalne Ø110 do WC rozciągane L-360-540 | B405 | 16 |
|  |  | Złącze mimośrodowe do WC | B515 | 24 |
|  |  | Złącze proste do WC | B516 | 24 |

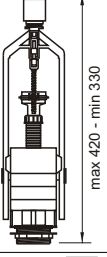

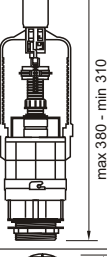

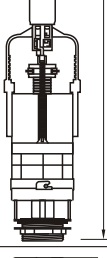

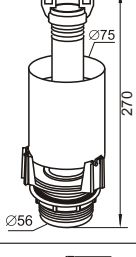

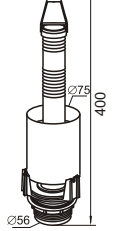

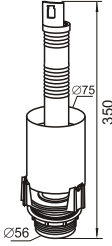

| PRODUKT | | | INDEX | OPK |
|---|---|---|-------|-----|
|  |  | <p>Kolano przyłączeniowe do WC $\varnothing 110/22$</p> | B500 | 15 |
|  |  | <p>Kolano przyłączeniowe do WC $\varnothing 110/45$</p> | B501 | 15 |
|  |  | <p>Kolano przyłączeniowe do WC $\varnothing 110/90$</p> | B503 | 20 |
|  |  | <p>Sztucer przyłączeniowy do WC $\varnothing 110 \times 150$</p> | B504 | 20 |
|  |  | <p>Sztucer przyłączeniowy do WC $\varnothing 110 \times 250$</p> | B505 | 20 |
|  |  | <p>Sztucer przyłączeniowy do WC $\varnothing 110 \times 400$</p> | B506 | 12 |
|  |  | <p>Rozeta do kolan i sztuczerów przyłączeniowych do WC</p> | B510 | 20 |

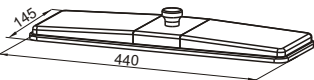

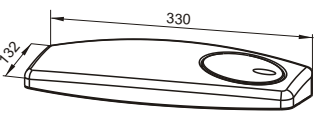

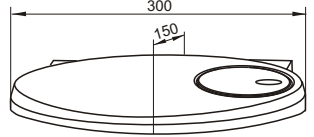

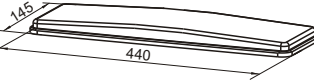

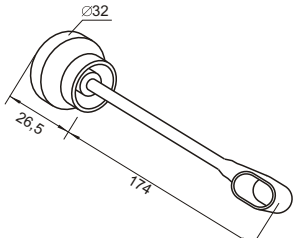

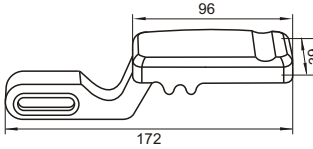

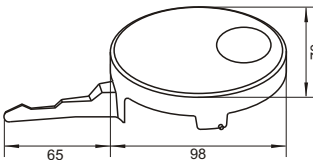
| PRODUKT | | | INDEX | OPK |
|---|---|--|-------|-----|
|  |  | <p>Kolano przyłączeniowe do WC $\varnothing 110 \times 90/90$ do spłuczki podtynkowej</p> | P100 | 1 |
|  |  | <p>Sztucer przyłączeniowy do WC $\varnothing 110 \times 150/90$ do spłuczki podtynkowej</p> | P101 | 1 |
|  |  | <p>Sztucer przyłączeniowy do WC $\varnothing 45 \times 190$ do spłuczki podtynkowej</p> | P102 | 1 |
|  |  | <p>Zestaw przyłączeniowo mocujący do WC do spłuczki podtynkowej</p> | P103 | 1 |
|  |  | <p>Korek montażowy duży do WC do spłuczki podtynkowej</p> | P104 | 1 |
|  |  | <p>Korek montażowy mały do WC do spłuczki podtynkowej</p> | P105 | 1 |
|  |  | <p>Rura kombinowana dolnopłuk</p> | B304 | 55 |

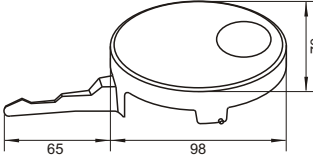
| PRODUKT | | | INDEX | OPK |
|---|---|--------------------------------|-------------|-----------|
|  |  | <p>Rura dolnołuk z ABS</p> | <p>B305</p> | <p>20</p> |
|  |  | <p>Rura górnołuk</p> | <p>B306</p> | <p>20</p> |
|  |  | <p>Kolano górnołuk</p> | <p>B307</p> | <p>20</p> |
|  |  | <p>Rura hokej</p> | <p>B308</p> | <p>20</p> |

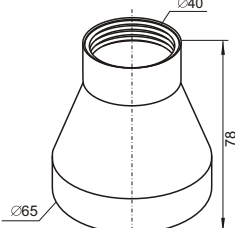

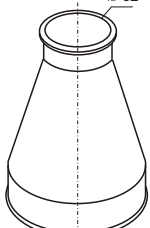

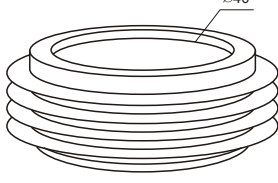

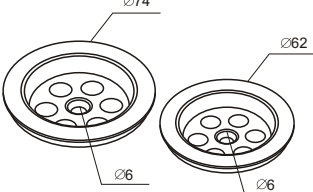

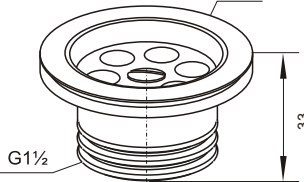

GRUPA VI: CZĘŚCI ZAMIENNE

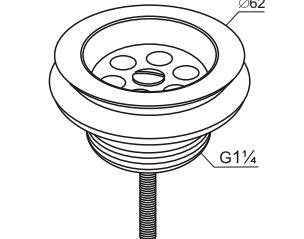

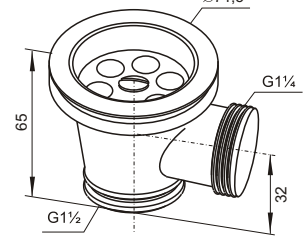

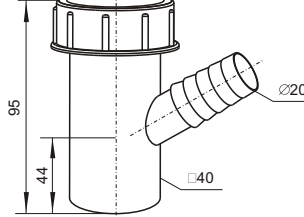
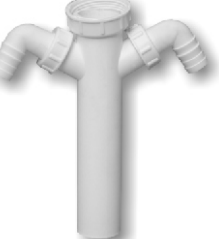
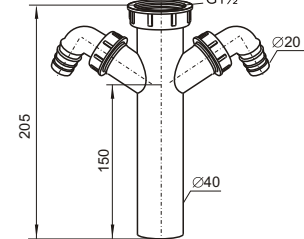

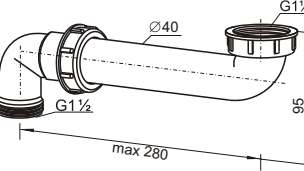

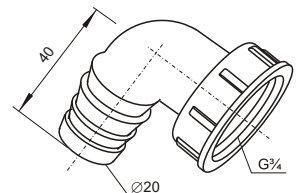

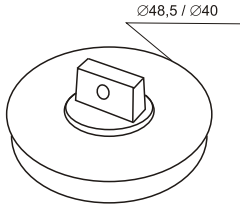

| PRODUKT | | | INDEX | OPK |
|---|---|---|-------|-----|
|  |  | <p>Zawór pływakowy napełniający 1/2" poziomy do spłuczek z tworzywa oraz ceramicznych</p> | E103 | 20 |
|  |  | <p>Zawór pływakowy napełniający 3/8" poziomy do spłuczek z tworzywa oraz ceramicznych</p> | E118 | 20 |
|  |  | <p>Zawór spłukujący z funkcją stop do spłuczki B109P, do spłuczek ceramicznych</p> | E403 | 12 |
|  |  | <p>Zawór spłukujący dwufunkcyjny 3-6 litra niski do spłuczek ceramicznych kompakt</p> | E404 | 10 |
|  |  | <p>Zawór spłukujący dwufunkcyjny 3-6 litra wysoki do spłuczek ceramicznych kompakt</p> | E405 | 10 |
|  |  | <p>Zawór spłukujący do spłuczek B101K; B103C; B104</p> | E105 | 20 |
|  |  | <p>Zawór spłukujący do spłuczki B106K</p> | E123 | 1 |

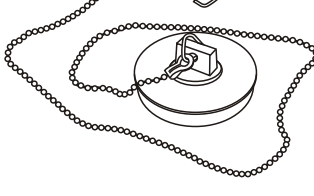

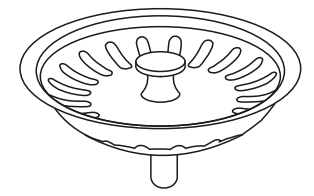

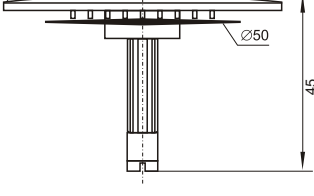

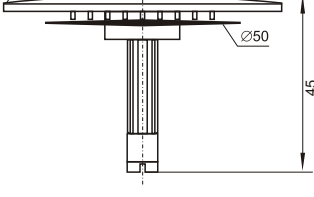

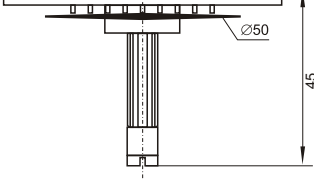

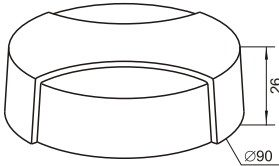
| PRODUKT | | | INDEX | OPK |
|---|---|--|-------|-----|
|  |  | <p>Zawór sflukujacy do sfluczki B107K</p> | E149 | 1 |
|  |  | <p>Pokrywa do sfluczki B101K</p> | E124 | 1 |
|  |  | <p>Pokrywa do sfluczki B103C</p> | E125 | 1 |
|  |  | <p>Pokrywa do sfluczki z klawiszem B106K</p> | E126 | 1 |
|  |  | <p>Pokrywa do sfluczki z klawiszem B107K</p> | E147 | 1 |
|  |  | <p>Pokrywa do sfluczki gornopfluk B104</p> | E127 | 1 |
|  |  | <p>Ciagno sfluczki B103C</p> | E117 | 50 |

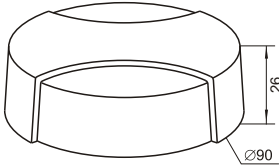

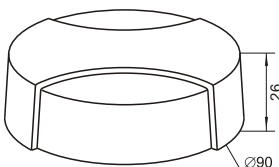

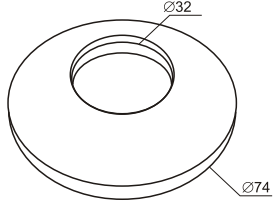

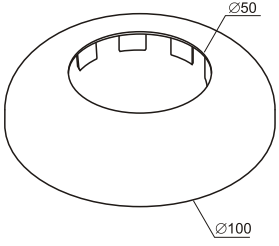
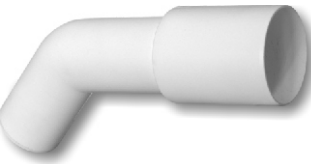
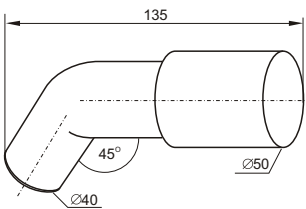
| PRODUKT | | | INDEX | OPK |
|---|---|--|-------|-----|
|  |  | <p>Klawisz spłuczki B101K</p> | E128 | 1 |
|  |  | <p>Klawisz spłuczki B106K z ABS</p> | E129 | 1 |
|  |  | <p>Klawisz spłuczki B107K; B108K z polipropylenu</p> | E148 | 1 |
|  |  | <p>Lej do podłączenia dolnopłuka</p> | E106 | 100 |
|  |  | <p>Lej do podłączenia górnopłuka</p> | E122 | 100 |
|  |  | <p>Uszczelka redukcyjna 55/45 do WC</p> | E392 | 50 |
|  |  | <p>Sitko metalowe umywalka</p> | E108M | 50 |
| | | <p>Sitko metalowe zlew , wanna , brodzik</p> | E107M | 50 |

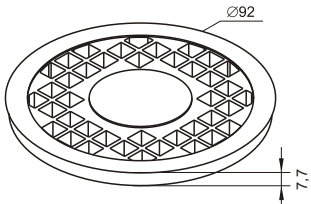

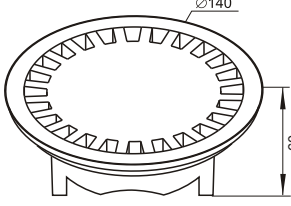
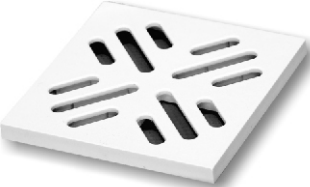
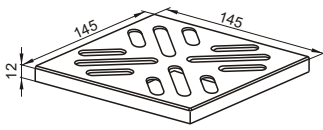

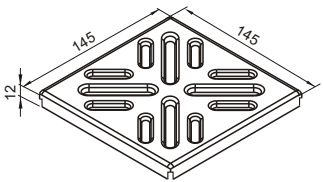
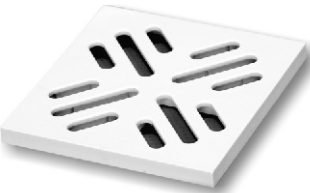
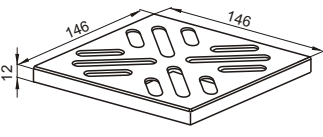
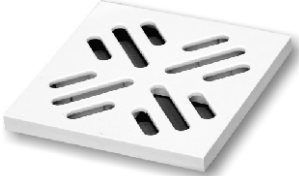
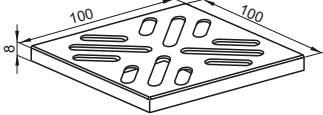

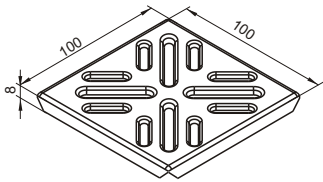

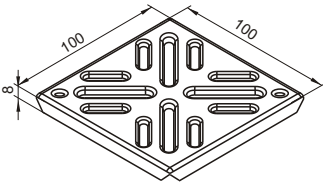

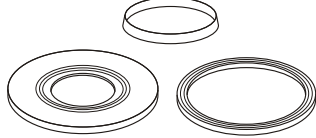
| PRODUKT | | | INDEX | OPK |
|---|---|---|-------|-----|
|  |  | <p>Sitko tworzywo umywalka</p> | E110T | 50 |
| | | <p>Sitko tworzywo zlew , wanna , brodzik</p> | E109T | 50 |
|  |  | <p>Sitko metalowe zlew do zlewozmywaków z otworami odpływowymi 3,5"</p> | E400 | 1 |
|  |  | <p>Gardziel umywalka sitko metalowe</p> | E111M | 10 |
| | | <p>Gardziel umywalka sitko tworzywo</p> | E112T | 10 |
|  |  | <p>Gardziel zlew podwójny brodzik sitko metalowe</p> | E113M | 10 |
| | | <p>Gardziel zlew.podw. brodzik sitko tworzywo</p> | E114T | 10 |
|  |  | <p>Gardziel zlew.podw. z kolankiem sitko metalowe</p> | E130M | 10 |
| | | <p>Gardziel zlew.podw. z kolankiem sitko tworzywo</p> | E131T | 10 |
|  |  | <p>Gardziel zlew pojed. sitko metalowe</p> | E116M | 10 |
| | | <p>Gardziel zlew pojed. sitko tworzywo</p> | E115T | 10 |
|  |  | <p>Gardziel zlew z nakrętką i zaślepką sitko metalowe</p> | E378M | 10 |

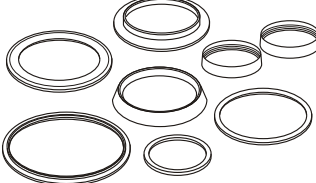
| PRODUKT | | | INDEX | OPK |
|---|---|--|-------|-----|
|  |  | <p>Gardziel zlew sitko metalowe</p> | E379M | 10 |
|  |  | <p>Gardziel umywalka sitko metalowe</p> | E395M | 10 |
|  |  | <p>Gardziel wanna sitko metalowe</p> | E132M | 10 |
| | | <p>Gardziel wanna sitko tworzywo</p> | E133T | 10 |
|  |  | <p>Złączka do syfonu zlew do podłączenia pralki, zmywarki z nakrętką</p> | E380 | 1 |
|  |  | <p>Rura do syfonu zlewozmywakowego z dwoma złączkami podłączeniowymi</p> | E381 | 1 |
|  |  | <p>Rura z kolanem do syfonu zlewozmywakowego</p> | E382 | 1 |
|  |  | <p>Złączka kątowa do przyłącza węża z nakrętką uszczelką i zaślepką</p> | E383 | 1 |

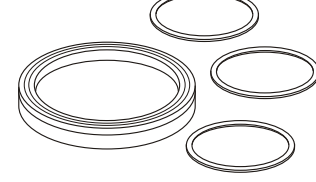
| PRODUKT | | | INDEX | OPK |
|--|---|--|-------|-----|
|  |  | Korek umywalka | E120 | 50 |
| | | Korek zlew, brodzik, wanna | E121 | 50 |
|  |  | Korek z łańcuszkiem do wanny łańcuszek 50 cm | E376 | 50 |
| | | Korek z łańcuszkiem do zlewu łańcuszek 25 cm | E377 | 50 |
|  |  | Korek z łańcuszkiem do umywalki łańcuszek 25 cm | E391 | 50 |
|  |  | Korek metalowy zlew do zlewozmywaków z otworami odpływowymi 3,5" | E401 | 1 |
|  |  | Korek do syfonu wannowego A305M50 nierdzewny | E384 | 1 |
|  |  | Korek do syfonu wannowego A315TM50 srebrny matowy | E385 | 1 |
|  |  | Korek do syfonu wannowego A314T50 biały | E386 | 1 |

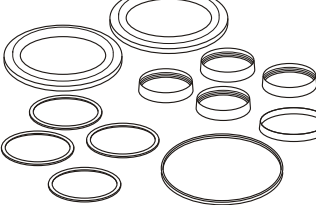
| PRODUKT | | | INDEX | OPK |
|---|---|--|-------|-----|
|  |  | Pokrętła do syfonu wannowego A305M50 chrom | E387 | 1 |
|  |  | Pokrętła do syfonu wannowego A315TM50 srebrny matowy | E388 | 1 |
|  |  | Pokrętła do syfonu wannowego A314T50 biały | E389 | 1 |
|  |  | Rozeta mała | E265 | 10 |
|  |  | Rozeta duża | E229 | 10 |
|  |  | Kolano odpływowe 50/40 do syfonu wannowego, brodzikowego | E402 | 20 |
|  |  | Ruszt biały do kratki C101B | E134B | 1 |
| | | Ruszt czarny do kratki C102C | E135C | 1 |

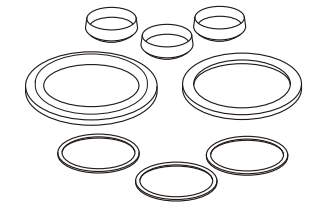
| PRODUKT | | | INDEX | OPK |
|---|---|--|-------|-----|
|  |  | Ruszt biały do kratki i wpustu C103B , C203B | E136B | 1 |
| | | Ruszt czarny do kratki i wpustu C104C , C204C | E137C | 1 |
|  |  | Ruszt biały do wpustu C201B , C207B | E138B | 1 |
| | | Ruszt czarny do wpustu C202C , C208C | E139C | 1 |
|  |  | Ruszt nierdzewny do wpustu C209N , C210N | E140N | 1 |
|  |  | Ruszt biały do wpustu C205B | E141B | 1 |
| | | Ruszt czarny do wpustu C206C | E142C | 1 |
|  |  | Ruszt biały do wpustu i kratki C211B; C105B | E143B | 1 |
| | | Ruszt popielaty do wpustu i kratki C212P; C106P | E144P | 1 |
|  |  | Ruszt nierdzewny do wpustu i kratki C213N; C107N | E145N | 1 |
|  |  | Ruszt nierdzewny do wpustu i kratki C214N; C108N przykręcany w komplecie z śrubami | E146N | 1 |

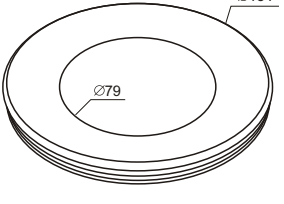
| PRODUKT | | | INDEX | OPK |
|---|---|---|-------------|-----------|
|  |  | <p>Komplet uszczelek do spłuczki</p> | <p>E370</p> | <p>20</p> |
|  |  | <p>Komplet uszczelek do syfonu umywalkowego</p> | <p>E371</p> | <p>20</p> |
|  |  | <p>Komplet uszczelek do syfonu brodzikowego</p> | <p>E372</p> | <p>20</p> |
|  |  | <p>Komplet uszczelek do syfonu zlewozmywakowego</p> | <p>E373</p> | <p>20</p> |
|  |  | <p>Komplet uszczelek do syfonu wannowego</p> | <p>E374</p> | <p>20</p> |
|  |  | <p>Uszczelka wargowa Ø110</p> | <p>E375</p> | <p>1</p> |

UWAGA ! Zakupy innych nie wymienionych części zamiennych prosimy uzgadniać bezpośrednio z działem sprzedaży.

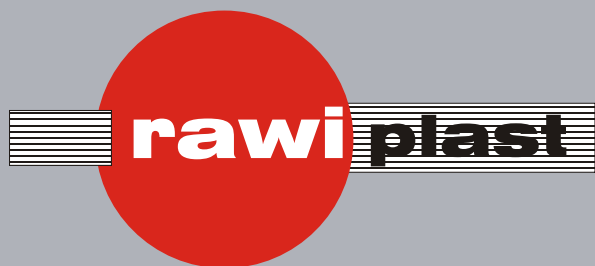

Winkiel Sp. z o.o.
ul. Cisowa 9, Niepruszewo
64-320 Buk
tel. 061 8968200
fax. 061 8968201
e-mail: sekretariat@rawiplast.pl

Dział sprzedaży
tel. 061 8968210
fax. 061 8968211